

Article number: 12736000040100

Description: KLEE-coil 736 000 040.100
M4 Steel

Measures

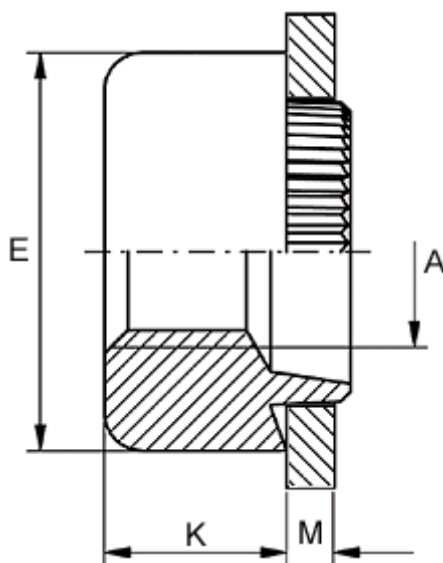

Female thread A	= M4
Height K	= 3.0
Outer diameter E	= 7.0
Plate thickness	= 4.4 to 4.6
Recommended bore diameter +0.05	= 6.0